

# PLAN VIEW

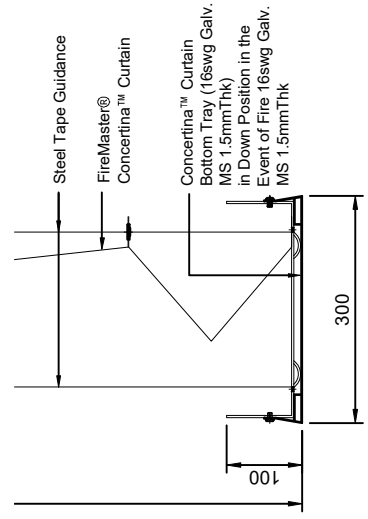
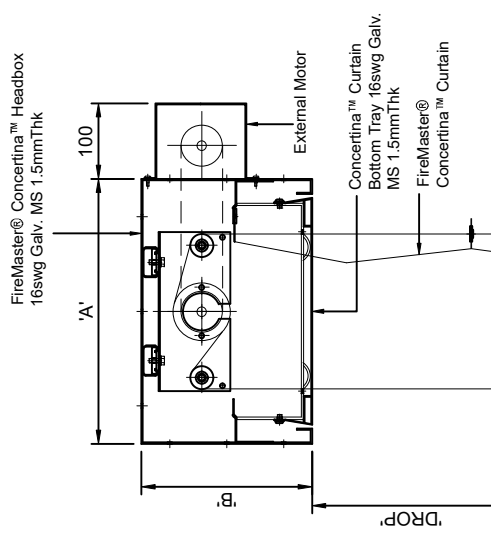
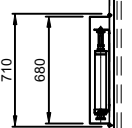

**NOTE**  
 1. THIS DRAWING SHOULD BE CONSIDERED AS A GUIDE ONLY. AS SOME DETAILS HAVE BEEN OMITTED FOR CLARITY  
 2. NUMBER OF MOTOR AND LOCATION DEPEND ON CURTAIN DIMENSION

<p><b>coopers</b> Coopers Fire Limited</p>		<p>Edward House, Penner Road,          Havant, Hampshire, PO9 1QZ, UK          Tel: +44 (0) 23 9245 4405          Fax: +44 (0) 23 9249 2732          Email: info@coopersfire.com          Web: www.coopersfire.com</p>	<p><b>TITLE:</b>          FIREMASTER® CONCERTINA™ CLOSED          FIRE BARRIER TYPICAL ARRANGEMENT</p> <p><small>© 1992 - 2014 COOPER GROUP LIMITED.          ALL RIGHTS RESERVED. THIS DESIGN MAY NOT BE REPRODUCED          OR TRANSMITTED IN ANY FORM OR BY ANY MEANS, WITHOUT          THE WRITTEN PERMISSION OF THE COPYRIGHT OWNERS.</small></p>	<p><b>ISSUE:</b> D  <b>DATE:</b> 18.11.2015</p>
<p><b>DRAWN:</b> ML</p>	<p><b>CHECKED:</b> JR</p>	<p><b>APPROVED:</b> C.JL</p>	<p><b>DRG. No.:</b> 604/001/MK</p>	<p><b>DATE:</b> 18.11.2015</p>

CURTAIN DIMENSION		HEADBOX SIZE	
X / Y	DROP	'A'	'B'
UNLIMITED	< 4M	350	225
UNLIMITED	> 4M < 8M	350	350

ANY SIZES OUTSIDE THOSE STATED PLEASE CONTACT COOPERS FIRE LTD

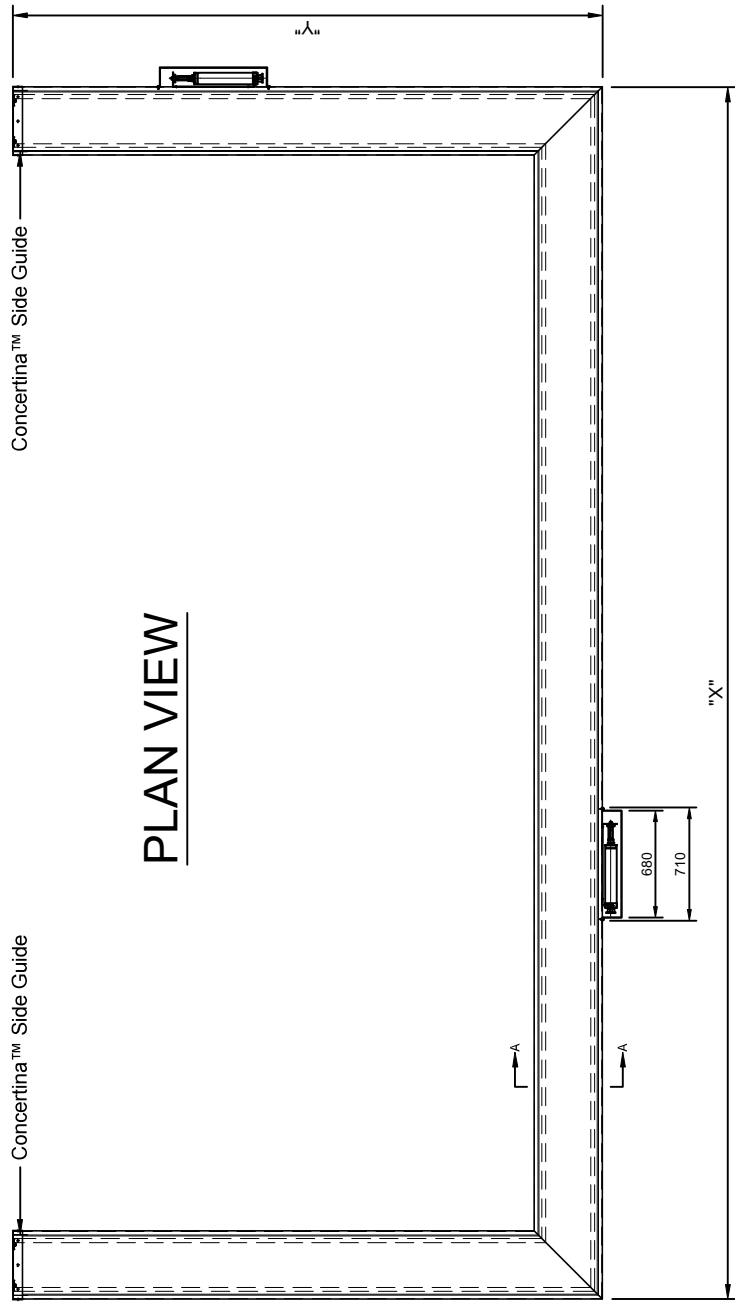

# PLAN VIEW

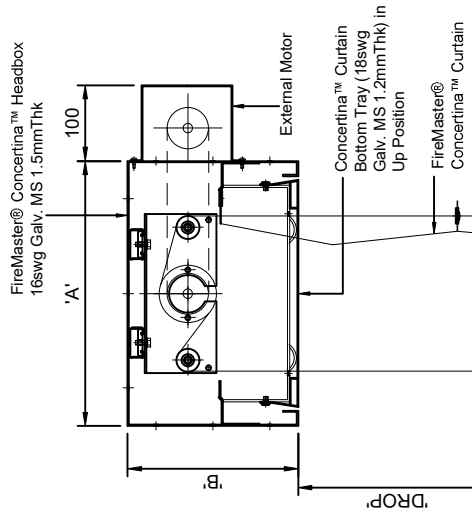

HEADBOX DETAIL

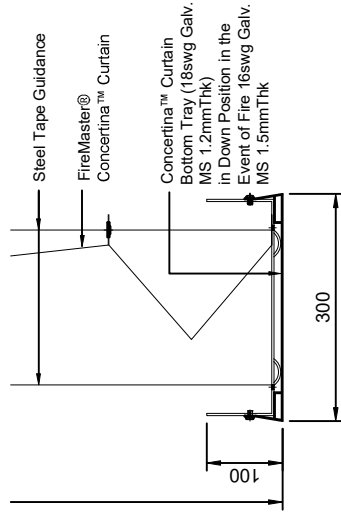

BOTTOM TRAY DETAIL SECTION A - A

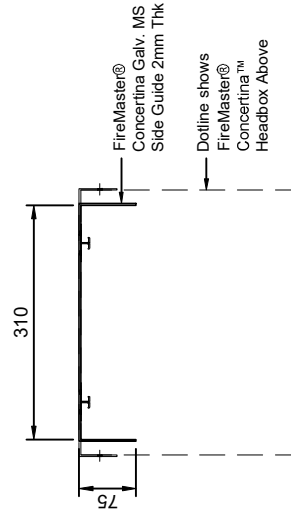

END SECTION SIDE GUIDE DETAIL

CURTAIN DIMENSION		HEADBOX SIZE	
X / Y	DROP	'A'	'B'
UNLIMITED	< 4M	350	225
UNLIMITED	> 4M < 8M	350	350

ANY SIZES OUTSIDE THOSE STATED PLEASE CONTACT COOPERS FIRE LTD

- NOTE
- THIS DRAWING SHOULD BE CONSIDERED AS A GUIDE ONLY. AS SOME DETAILS HAVE BEEN OMITTED FOR CLARITY
  - NUMBER OF MOTOR AND LOCATION DEPEND ON CURTAIN DIMENSION

 <b>coopers</b> Coopers Fire Limited		Edward House, Penner Road, Havant, Hampshire, PO9 1QZ, UK Tel: +44 (0) 23 9245 4405 Fax: +44 (0) 23 9289 2732 Email: info@coopersfire.com Web: www.coopersfire.com	DRAWN: ML CHECKED: JR APPROVED: C.J.L.	TITLE: FIREMASTER® CONCERTINA™ OPEN FIRE BARRIER TYPICAL ARRANGEMENT <small>© 1992 - 2014 COOPERS GROUP LIMITED. ALL RIGHTS RESERVED. THIS DESIGN MAY NOT BE REPRODUCED OR TRANSMITTED IN ANY FORM OR BY ANY MEANS, WITHOUT THE WRITTEN PERMISSION OF THE COPYRIGHT OWNERS.</small>	DRG. No. 604/002/MK ISSUE: D DATE: 18.11.2015
--	--	---	--	--	---

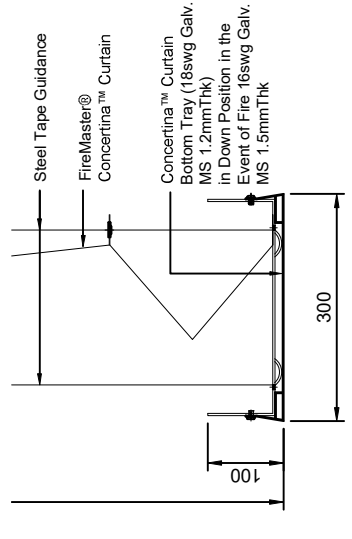
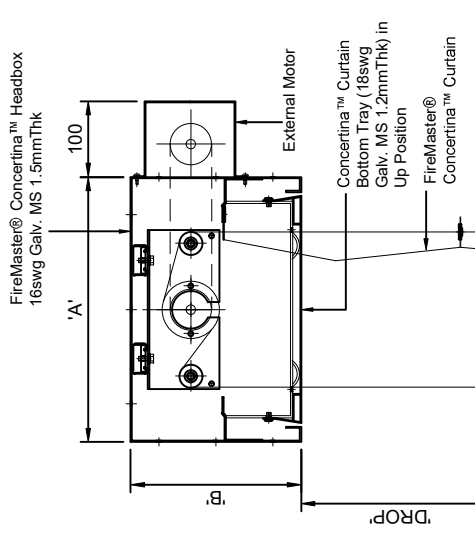
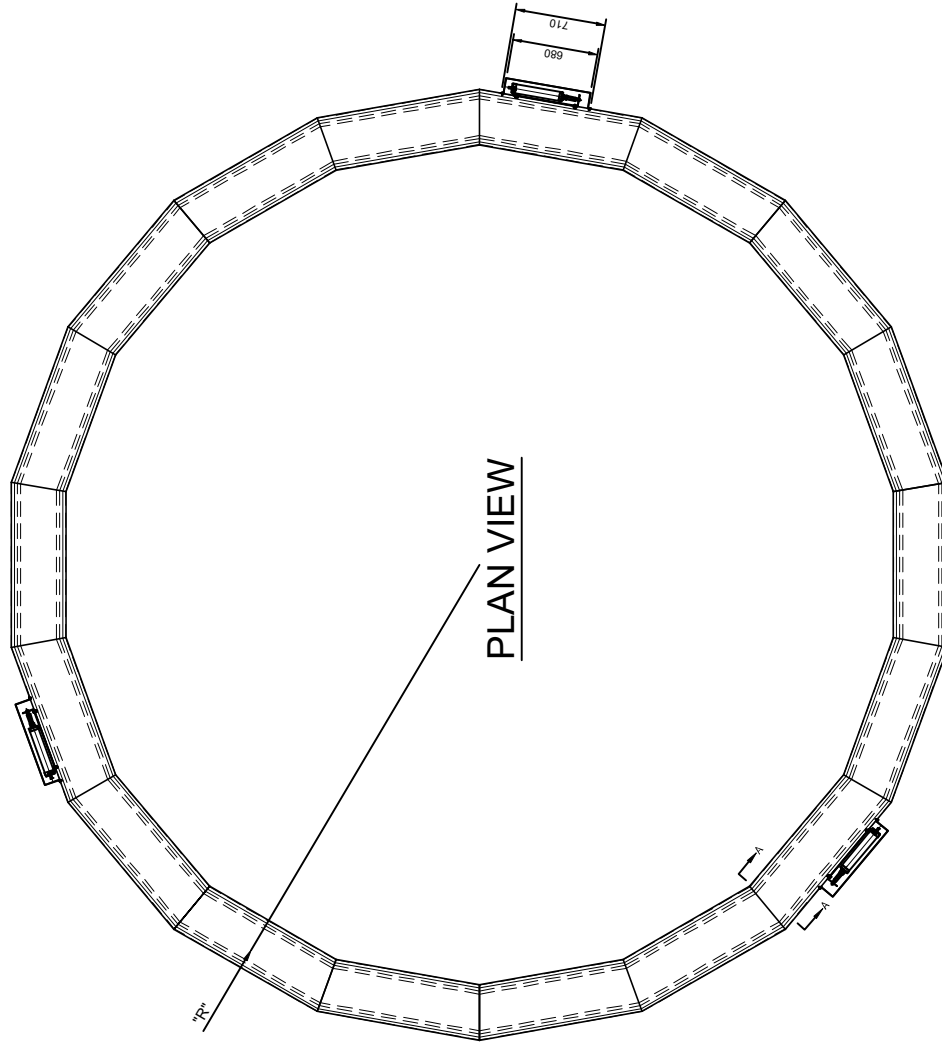

NOTE  
 1. THIS DRAWING SHOULD BE CONSIDERED AS A GUIDE ONLY. AS SOME DETAILS HAVE BEEN OMITTED FOR CLARITY  
 2. NUMBER OF MOTOR AND LOCATION DEPEND ON CURTAIN DIMENSION

CURTAIN DIMENSION		HEADBOX SIZE	
R	DROP	'A'	'B'
UNLIMITED	< 4M	350	225
UNLIMITED	> 4M < 8M	350	350

ANY SIZES OUTSIDE THOSE STATED PLEASE CONTACT COOPERS FIRE LTD

**coopers**  
Coopers Fire Limited

Edward House, Penner Road,  
Havant, Hampshire, PO9 1QZ, UK  
 Tel: +44 (0) 23 9245 4405  
 Fax: +44 (0) 23 9287 2732  
 Email: info@coopersfire.com  
 Web: www.coopersfire.com

**TITLE:** FIREMASTER® CONCERTINA™ CIRCULAR FIRE BARRIER TYPICAL ARRANGEMENT  
© 1992 - 2014 COOPERS GROUP LIMITED. ALL RIGHTS RESERVED. THIS DESIGN MAY NOT BE REPRODUCED OR TRANSMITTED IN ANY FORM OR BY ANY MEANS WITHOUT THE WRITTEN PERMISSION OF THE COPYRIGHT OWNERS.

**ISSUE:** B  
**DATE:** 18.11.2015

**DRG. No.** 604/003/MK

**DRAWN:** JR  
**CHECKED:** JR  
**APPROVED:** C.J.L.

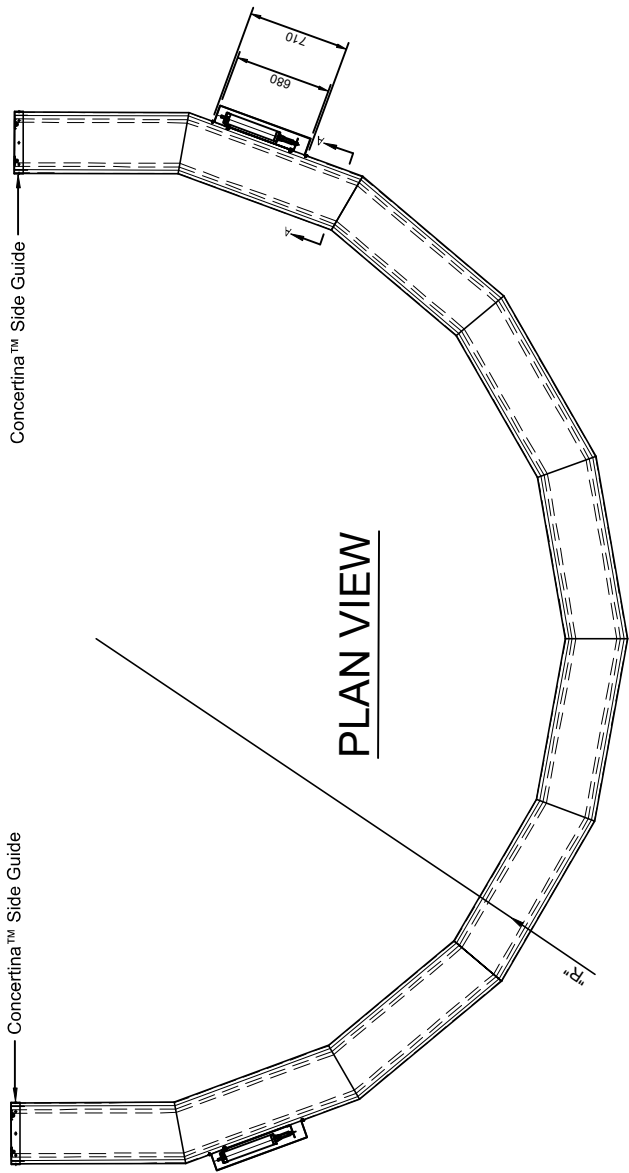

# PLAN VIEW

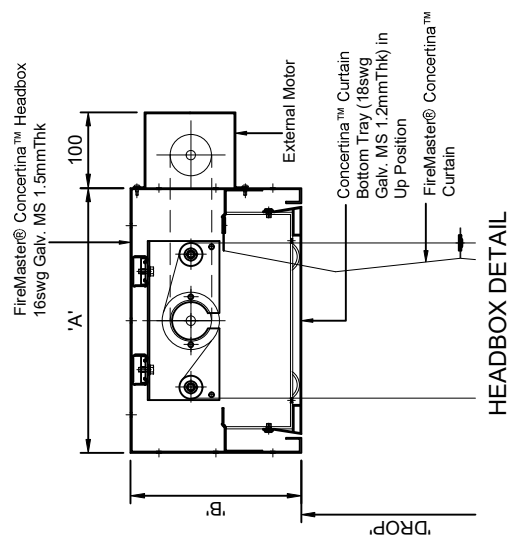

HEADBOX DETAIL

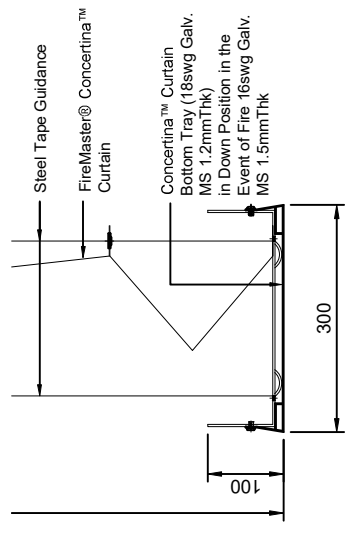

BOTTOM TRAY DETAIL SECTION A - A

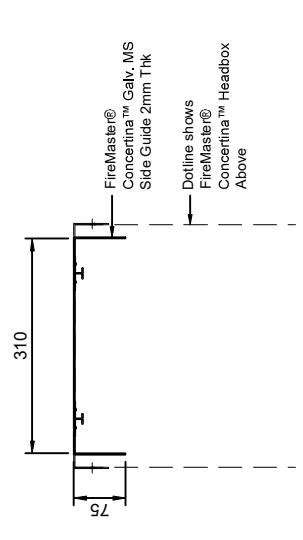

CURTAIN DIMENSION	HEADBOX SIZE	
R	'A'	'B'
UNLIMITED	< 4M	225
UNLIMITED	> 4M < 8M	350

ANY SIZES OUTSIDE THOSE STATED PLEASE CONTACT COOPERS FIRE LTD

- NOTE
- THIS DRAWING SHOULD BE CONSIDERED AS A GUIDE ONLY, AS SOME DETAILS HAVE BEEN OMITTED FOR CLARITY
  - NUMBER OF MOTOR AND LOCATION DEPEND ON CURTAIN DIMENSION

 <b>coopers</b> Coopers Fire Limited		Edward House, Penner Road, Havant, Hampshire, PO9 1QZ, UK Tel: +44 (0) 23 9245 4405 Fax: +44 (0) 23 9287 2732 Email: info@coopersfire.com Web: www.coopersfire.com	
DRAWN:	JR	TITLE:	FIREMASTER® CONCERTINA™ SEMI CIRCULAR FIRE BARRIER TYPICAL ARRANGEMENT
CHECKED:	JR	© 1992 - 2014 COOPERS GROUP LIMITED. ALL RIGHTS RESERVED. THIS DESIGN MAY NOT BE REPRODUCED OR TRANSMITTED IN ANY FORM OR BY ANY MEANS WITHOUT THE WRITTEN PERMISSION OF THE COPYRIGHT OWNERS.	ALL DIMENSION IN MILLIMETERS UNLESS OTHERWISE STATED
APPROVED:	C.J.L	DRG. No.	604/004/MK
		ISSUE:	B
		DATE:	18.11.2015

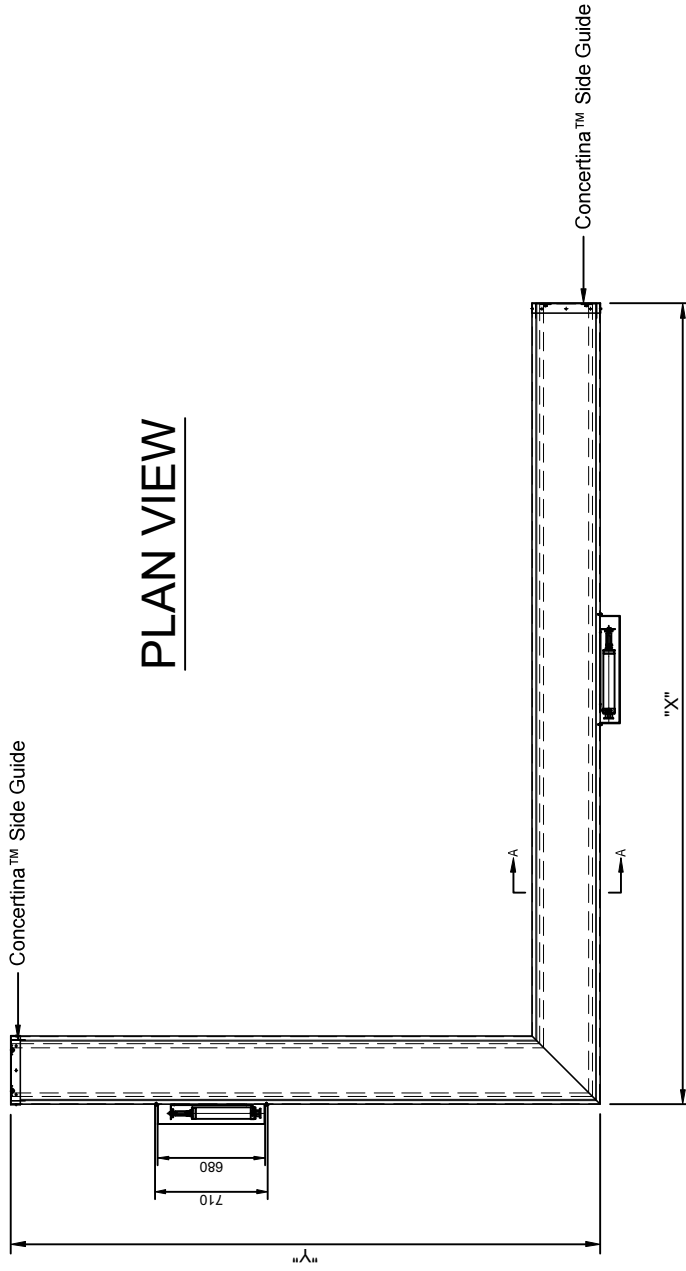

# PLAN VIEW

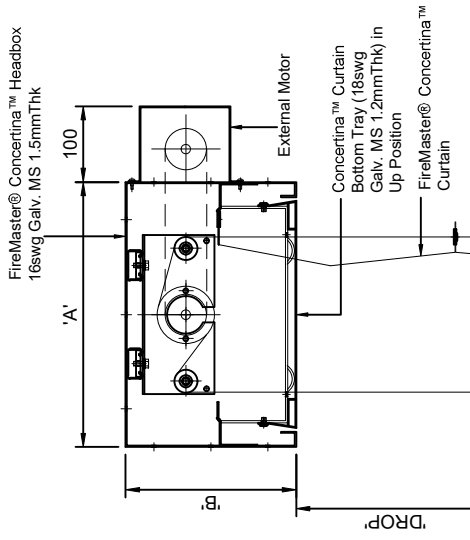

HEADBOX DETAIL

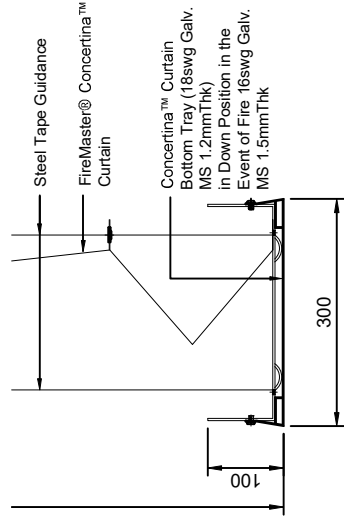

BOTTOM TRAY DETAIL SECTION A - A

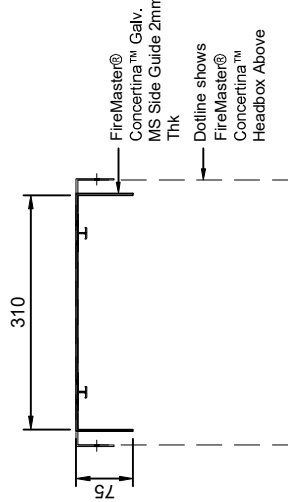

END SECTION SIDE GUIDE DETAIL

CURTAIN DIMENSION		HEADBOX SIZE	
X / Y	DROP	'A'	'B'
UNLIMITED	< 4M	350	225
UNLIMITED	> 4M < 8M	350	350

ANY SIZES OUTSIDE THOSE STATED PLEASE CONTACT COOPERS FIRE LTD

- NOTE  
 1. THIS DRAWING SHOULD BE CONSIDERED AS A GUIDE ONLY. AS SOME DETAILS HAVE BEEN OMITTED FOR CLARITY  
 2. NUMBER OF MOTOR AND LOCATION DEPEND ON CURTAIN DIMENSION

 <b>coopers</b> Coopers Fire Limited		Edward House, Penner Road, Havant, Hampshire, PO9 1QZ, UK Tel: +44 (0) 23 9245 4405 Fax: +44 (0) 23 9249 2732 Email: info@coopersfire.com Web: www.coopersfire.com
DRAWN: JR CHECKED: JR APPROVED: C.J.L.	TITLE: FIREMASTER® CONCERTINA™ "L" OPEN FIRE BARRIER TYPICAL ARRANGEMENT <small>© 1992 - 2014 COOPERS GROUP LIMITED. ALL RIGHTS RESERVED. THIS DESIGN MAY NOT BE REPRODUCED OR TRANSMITTED IN ANY FORM OR BY ANY MEANS WITHOUT THE WRITTEN PERMISSION OF THE COPYRIGHT OWNERS.</small>	DRG. No. 604/005/MK ISSUE: B DATE: 18.11.2015